

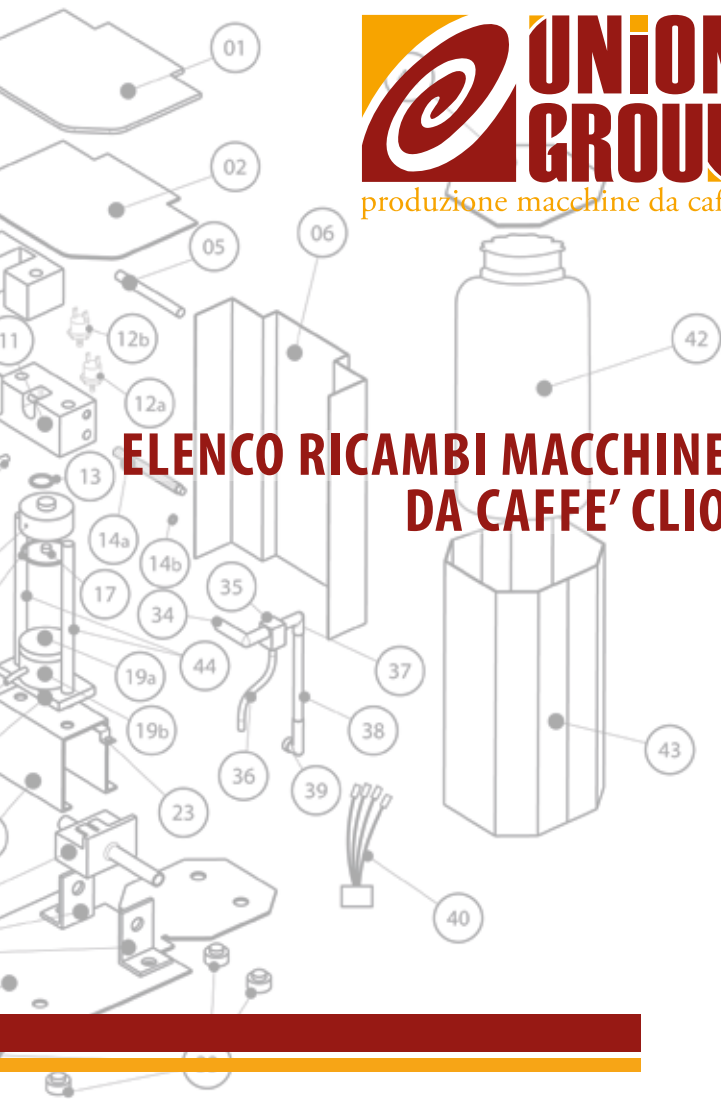

produzione macchine da caffè

ELENCO RICAMBI MACCHINE DA CAFFÈ' CLIO





ELENCO RICAMBI CLIO



POSIZIONE	CODICE	DESCRIZIONE
1	UGCL-01	COPERCHIO IN PLASTICA
2	UGCL-02	COPERCHIO INTERNO
3	UGCL-03	RESISTENZA 230V / 450W
4	UGCL-04	BLOCCO ALLUMINIO SUPERIORE
5	UGCL-05	SPINETTA GRANDE PER SNODO
6	UGCL-06	CARTER POSTERIORE
7	UGCL-07	SNODO SUPERIORE
8	UGCL-08	LEVA
9	UGCL-09	POMELLO VARI COLORI
10	UGCL-10	SNODO INFERIORE
11	UGCL-11	SCAMBIATORE ALLUMINIO
12a	UGCL-12a	TERMOSTATO 90°
12b	UGCL-12b	TERMOSTATO 165°
13	UGCL-13	GUARNIZIONE OR 125
14a	UGCL-14a	PERNO LABIRINTO
14b	UGCL-14b	GUARNIZIONE PER SILURO
15	UGCL-15	SPINETTA PICCOLA PER SNODO
16	UGCL-16	SFERA SUPERIORE ALLUMINIO
17	UGCL-17	PERNO FILETTATO PER SFERA
18	UGCL-18	GUARNIZIONE OR 149
19a	UGCL-19a	FILTRO PER CIALDA
19b	UGCL-19b	PORTA CIALDA IN DERLIN NERO
20	UGCL-20	BECCUCCIO ACCIAIO INOX
21	UGCL-21	PIASTRA INFERIORE
22	UGCL-22	SUPPORTO INFERIORE
23	UGCL-23	STAFFETTA PER TUBO SCARICO
24	UGCL-24	POMPA EP5FM 230V / 450W
25	UGCL-25	ANTI VIBRANTE A SQUADRA

POSIZIONE	CODICE	DESCRIZIONE
26	UGCL-26	BASE
27	UGCL-27	CAVO DI ALIMENTAZIONE
28	UGCL-28	FRONTALE ANTERIORE
29	UGCL-29	STAFFA FRONTALE IN ACCIAIO
30a	UGCL-30a	TASTO DI ACCENZIONE
30b	UGCL-30b	TASTO DI EROGAZIONE
31	UGCL-31	GRIGLIA POGGIA BICCHIERINO
32	UGCL-32	VASCHETTA RACCOGLI GOCCE
33	UGCL-33	PIEDINI IN GOMMA
34	UGCL-34	RACCORDO UNIVERSALE A "L"
35	UGCL-35	ELETTRIVALVOLA 3 VIE 230V / 450W
36	UGCL-36	TUBO SILICONATO
37	UGCL-37	RACCORDO A "L" COMPLETO
38	UGCL-38	TUBO TEFLON
39	UGCL-39	RACCORDI ANIMA
40	UGCL-40	CABLAGGIO
41	UGCL-41	COPERCHIO PER CESTELLO
42	UGCL-42	BOTTIGLIA DA 1 LITRO
43	UGCL-43	CESTELLO
44	UGCL-44	COLONNE MACCHINA
45	UGCL-45	SISTEMA DECONTO
46	UGCL-46	SISTEMA GETTONIERA
47	UGVPR-01	TERMO 200
48	UGVPR-02	TUBO A TRECCIA
49	UGVPR-03	EROGATORE
50	UGVPR-04	CALDAIA
51	UGVPR-05	MINI POMPA
52	UGVPR-06	TERMOSTATO 145°

1 COPERCHIO IN PLASTICA



2 COPERCHIO INTERNO



3 RESISTENZA 230V / 450W



4 BLOCCO ALLUMINIO



5 SPINETTA GRANDE PER SNODO



6 CARTER POSTERIORE



7 SNODO SUPERIORE



8 LEVA



9 POMELLI VARI COLORI

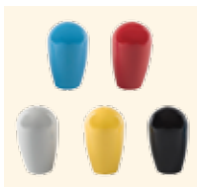

10 SNODO INFERIORE



11 SCAMBIATORE ALLUMINIO



12a TERMOSTATO 90°



12a TERMOSTATO 165°

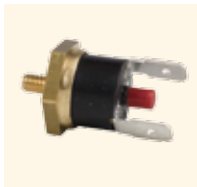

13 GUARNIZIONE OR 125



14a PERNO LABIRINTO



14b GUARNIZIONE PER SILURO



15 SPINETTA PICCOLA SNODO



16 SFERA SUP. ALLUMINIO



17 PERNO FILETTATO
PER SFERA



18 GUARNIZIONE OR 149

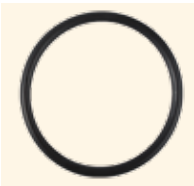

19a FILTRO PER CIALDA



19b PORTA CIALDA IN
DERLIN NERO



20 BECCUCCIO ACCIAIO INOX



21 PIASTRA INFERIORE



22 SUPPORTO INFERIORE



23 STAFFETTA PER TUBO



24 POMPA EP5FM
230V / 450W



25 ANTI VIBRANTE A
SQUADRA



26 BASE

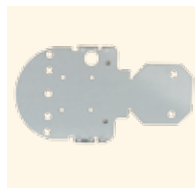

27 CAVO DI ALIMENTAZIONE



28 FRONTALE ANTERIORE



29 STAFFA FRONTALE IN
ACCIAIO



30a TASTO DI ACCENZIONE



30b TASTO DI EROGAZIONE



31 GRIGLIA POGGIA
BICCHIERINO



32 VASCHETTA RACCOLTI
GOCCE



33 PIEDINI IN GOMMA

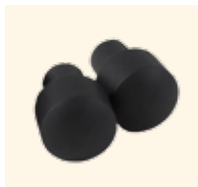

34 RACCORDO UNIVERSALE
MODELLO A "L"



35 ELETTROVALVOLA 3 VIE
230V / 450W

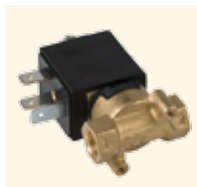

36 TUBO SILICONATO



37 RACCORDO A "L"



38 TUBO IN TEFLON

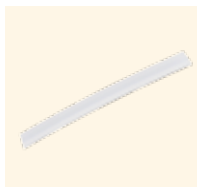

39 RACCORDI ANIMA



40 CABLAGGIO

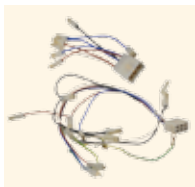

41 COPERCHIO PER
CESTELLO



42 BOTTIGLIA DA 1 LITRO



43 CESTELLO



44 COLONNE MACCHINA



ALTRI RICAMBI / ACCESSORI

45 SISTEMA DECONTO

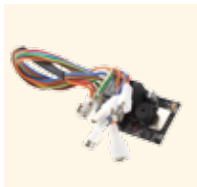

46 SISTEMA GETTONIERA



47 VAPORE: TERMO 200



48 VAPORE: TUBO A TRECCIA



49 VAPORE: EROGATORE



50 VAPORE: CALDAIA



51 MINI POMPA



52 TERMOSTATO 145°

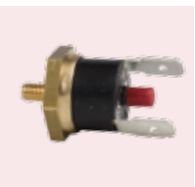



POS.	CODICE	DESCRIZIONE	QUANTITA'
1	UGCL-01	COPERCHIO IN PLASTICA	-----
2	UGCL-02	COPERCHIO INTERNO	-----
3	UGCL-03	RESISTENZA 230V / 450W	-----
4	UGCL-04	BLOCCO ALLUMINIO SUPERIORE	-----
5	UGCL-05	SPINETTA GRANDE PER SNODO	-----
6	UGCL-06	CARTER POSTERIORE	-----
7	UGCL-07	SNODO SUPERIORE	-----
8	UGCL-08	LEVA	-----
9	UGCL-09	POMELLO VARI COLORI	-----
10	UGCL-10	SNODO INFERIORE	-----
11	UGCL-11	SCAMBIATORE ALLUMINIO	-----
12a	UGCL-12a	TERMOSTATO 90°	-----
12b	UGCL-12b	TERMOSTATO 165°	-----
13	UGCL-13	GUARNIZIONE OR 125	-----
14a	UGCL-14a	PERNO LABIRINTO	-----
14b	UGCL-14b	GUARNIZIONE PER SILURO	-----
15	UGCL-15	SPINETTA PICCOLA PER SNODO	-----
16	UGCL-16	SFERA SUPERIORE ALLUMINIO	-----
17	UGCL-17	PERNO FILETTATO PER SFERA	-----
18	UGCL-18	GUARNIZIONE OR 149	-----
19a	UGCL-19a	FILTRO PER CIALDA	-----
19b	UGCL-19b	PORTA CIALDA IN DERLIN NERO	-----
20	UGCL-20	BECCUCCIO ACCIAIO INOX	-----
21	UGCL-21	PIASTRA INFERIORE	-----
22	UGCL-22	SUPPORTO INFERIORE	-----
23	UGCL-23	STAFFETTA PER TUBO SCARICO	-----
24	UGCL-24	POMPA EP5FM 230V / 450W	-----
25	UGCL-25	ANTI VIBRANTE A SQUADRA	-----

POS.	CODICE	DESCRIZIONE	QUANTITA'
26	UGCL-26	BASE	-----
27	UGCL-27	CAVO DI ALIMENTAZIONE	-----
28	UGCL-28	FRONTALE ANTERIORE	-----
29	UGCL-29	STAFFA FRONTALE IN ACCIAIO	-----
30a	UGCL-30a	TASTO DI ACCENZIONE	-----
30b	UGCL-30b	TASTO DI EROGAZIONE	-----
31	UGCL-31	GRIGLIA POGGIA BICCHIERINO	-----
32	UGCL-32	VASCHETTA RACCOGLI GOCCE	-----
33	UGCL-33	PIEDINI IN GOMMA	-----
34	UGCL-34	RACCORDO UNIVERSALE A "L"	-----
35	UGCL-35	ELETTROVALVOLA 3 VIE 230V / 450W	-----
36	UGCL-36	TUBO SILICONATO	-----
37	UGCL-37	RACCORDO A "L" COMPLETO	-----
38	UGCL-38	TUBO TEFLON	-----
39	UGCL-39	RACCORDI ANIMA	-----
40	UGCL-40	CABLAGGIO	-----
41	UGCL-41	COPERCHIO PER CESTELLO	-----
42	UGCL-42	BOTTIGLIA DA 1 LITRO	-----
43	UGCL-43	CESTELLO	-----
44	UGCL-44	COLONNE MACCHINA	-----
45	UGCL-45	SISTEMA DECONTO	-----
46	UGCL-46	SISTEMA GETTONIERA	-----
47	UGVPR-01	TERMO 200	-----
48	UGVPR-02	TUBO A TRECCIA	-----
49	UGVPR-03	EROGATORE	-----
50	UGVPR-04	CALDAIA	-----
51	UGVPR-05	MINI POMPA	-----
52	UGVPR-06	TERMOSTATO 145°	-----

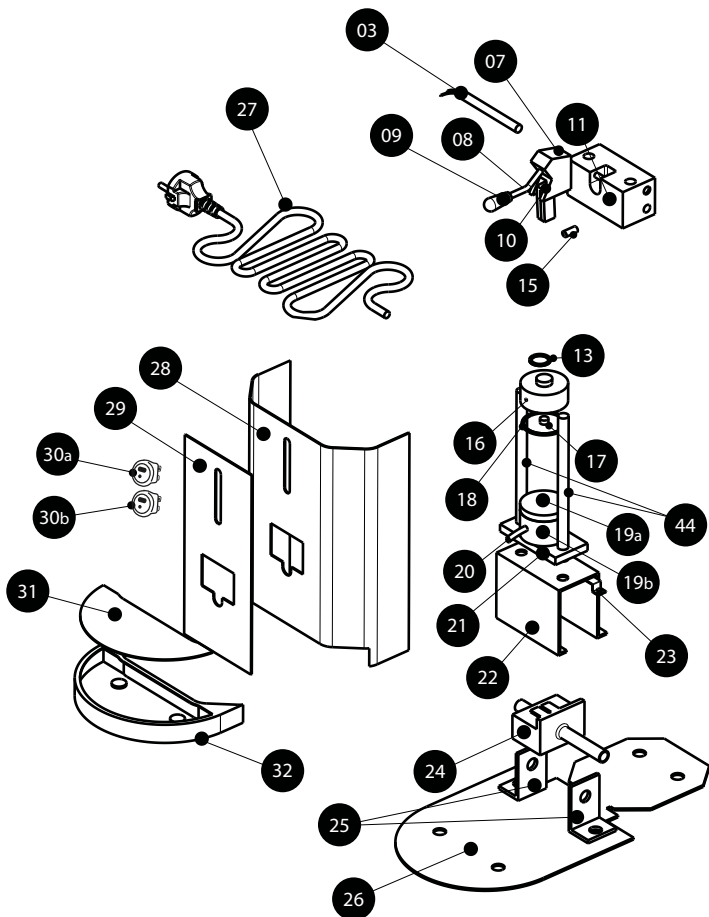

FOTOCOPIARE IL MODULO ORDINE PER EFFETTUARE LA RICHIESTA DI RICAMBI. CONTATTATE LA UNION GROUP PER I RELATIVI COSTI. LE SPEDIZIONI SONO A CARICO DEL RICHIEDENTE PER QUALSIASI IMPORTO. INVIARE IL PRESENTE MODULO A: ordini@uniongroup.it

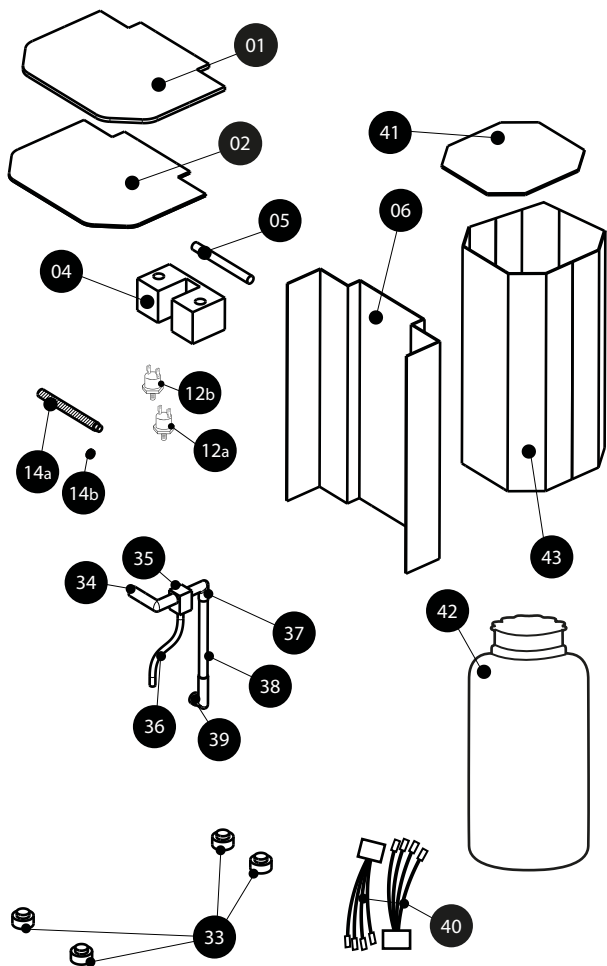

Nel presente elenco ricambi e nelle foto riportate, non sono rispettate le proporzioni reali tra i pezzi, al fine di meglio esporre i componenti interni delle macchine da caffè.

LA UNION GROUP SI RISERVA IL DIRITTO DI APPORTARE MODIFICHE TECNICHE E/O ESTETICHE AI PRODOTTI AL FINE DI MIGLIORARNE LE PRESTAZIONI. TUTTI I DIRITTI RISERVATI.

I disegni presenti in questo catalogo, sono stati realizzati dalla Union Group S.a.s., qualsiasi eventuale somiglianza è riconducibile alla similarità degli articoli in commercio. Ne è vietata la riproduzione, anche parziale, senza autorizzazione scritta della Union Group S.a.s.

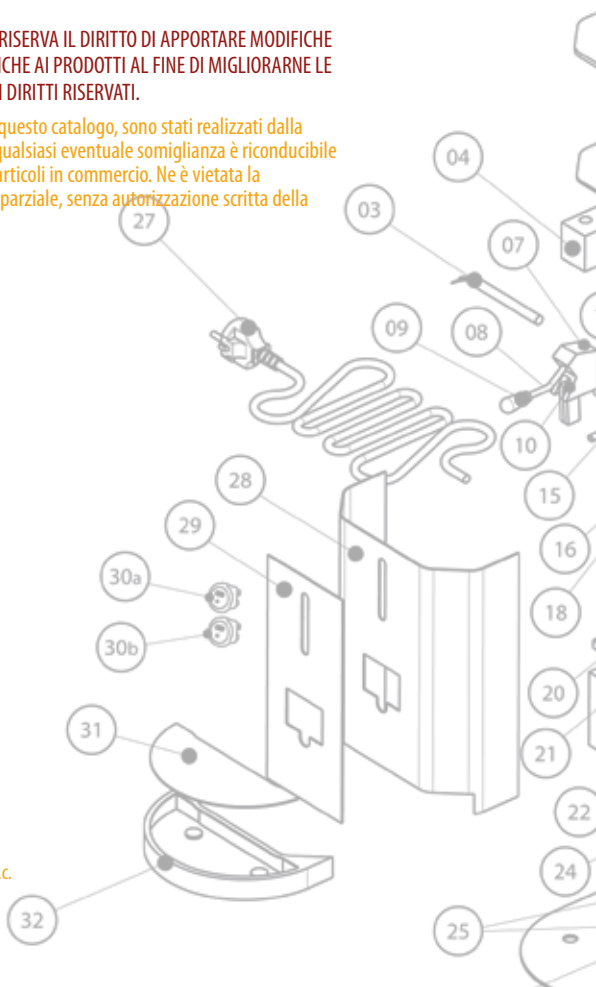

UNION GROUP S.a.s.

Via San Marco
1° Trav. Sarrichione s.n.c.
80021 Afragola (Na)

P.IVA 04951281213
www.uniongroup.it